

# Technical Data Sheet

**Agilent Technologies**

**33320A/B/G/H**

**33321A/B/D/G/H/K**

**33322A/B/G/H**

**33323K**

**Step Attenuators**

**For OEM & System Use**

**dc to 26.5 GHz**



**Agilent Technologies**

**Manufacturing Part Number: 5959-7857**

**Printed in USA**

**Print Date: May 1990**

© Agilent Technologies, Inc. 1990

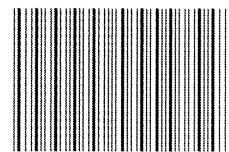

5959-7857

---

## **Hewlett-Packard to Agilent Technologies Transition**

This manual may contain references to HP or Hewlett-Packard. Please note that Hewlett-Packard's former test and measurement, semiconductor products and chemical analysis businesses are now part of Agilent Technologies. To reduce potential confusion, the only change to product numbers and names has been in the company name prefix: where a product number/name was HP XXXX the current name/number is now Agilent XXXX. For example, model number HP 33323K is now model number Agilent 33323K.

---

## **Documentation Warranty**

THE MATERIAL CONTAINED IN THIS DOCUMENT IS PROVIDED "AS IS," AND IS SUBJECT TO BEING CHANGED, WITHOUT NOTICE, IN FUTURE EDITIONS. FURTHER, TO THE MAXIMUM EXTENT PERMITTED BY APPLICABLE LAW, AGILENT DISCLAIMS ALL WARRANTIES, EITHER EXPRESS OR IMPLIED WITH REGARD TO THIS MANUAL AND ANY INFORMATION CONTAINED HEREIN, INCLUDING BUT NOT LIMITED TO THE IMPLIED WARRANTIES OF MERCHANTABILITY AND FITNESS FOR A PARTICULAR PURPOSE. AGILENT SHALL NOT BE LIABLE FOR ERRORS OR FOR INCIDENTAL OR CONSEQUENTIAL DAMAGES IN CONNECTION WITH THE FURNISHING, USE, OR PERFORMANCE OF THIS DOCUMENT OR ANY INFORMATION CONTAINED HEREIN. SHOULD AGILENT AND THE USER HAVE A SEPARATE WRITTEN AGREEMENT WITH WARRANTY TERMS COVERING THE MATERIAL IN THIS DOCUMENT THAT CONFLICT WITH THESE TERMS, THE WARRANTY TERMS IN THE SEPARATE AGREEMENT WILL CONTROL.

---

## **DFARS/Restricted Rights Notice**

If software is for use in the performance of a U.S. Government prime contract or subcontract, Software is delivered and licensed as "Commercial computer software" as defined in DFAR 252.227-7014 (June 1995), or as a "commercial item" as defined in FAR 2.101(a) or as "Restricted computer software" as defined in FAR 52.227-19 (June 1987) or any equivalent agency regulation or contract clause. Use, duplication or disclosure of Software is subject to Agilent Technologies' standard commercial license terms, and non-DOD Departments and Agencies of the U.S. Government will receive no greater than Restricted Rights as defined in FAR 52.227-19(c)(1-2) (June 1987). U.S. Government users will receive no greater than Limited Rights as defined in FAR 52.227-14 (June 1987) or DFAR 252.227-7015 (b)(2) (November 1995), as applicable in any technical data.

---

---

## Printing Copies of Documentation from the Web

To print copies of documentation from the Web, download the PDF file from the Agilent web site:

- Go to <http://www.agilent.com>.
  - Enter the document's part number (located on the title page) in the **Quick Search** box.
  - Click GO.
  - Click on the hyperlink for the document.
  - Click the printer icon located in the tool bar.
-

# Contacting Agilent

This information supersedes all prior HP contact information.			
<b>Online assistance:</b> <a href="http://www.agilent.com/find/assist">www.agilent.com/find/assist</a>			
<b>Americas</b>			
<b>Brazil</b> (tel) (+55) 11 3351 7012 (fax) (+55) 11 3351 7024	<b>Canada</b> (tel) +1 877 894 4414 (fax) +1 303 662 3369	<b>Mexico</b> (tel) 1 800 254 2440 (fax) 1 800 254 4222	<b>United States</b> (tel) 800 829 4444 (alt) (+1) 303 662 3998 (fax) 800 829 4433
<b>Asia Pacific and Japan</b>			
<b>Australia</b> (tel) 1 800 225 574 (fax) 1 800 681 776 (fax) 1 800 225 539	<b>China</b> (tel) 800 810 0508 (alt) 800 810 0510 (fax) 800 810 0507 (fax) 800 810 0362	<b>Hong Kong</b> (tel) 800 933 229 (fax) 800 900 701	<b>India</b> (tel) 1600 112 626 (fax) 1600 112 727 (fax) 1600 113 040
<b>Japan (Bench)</b> (tel) 0120 32 0119 (alt) (+81) 426 56 7799 (fax) 0120 01 2144	<b>Japan (On-Site)</b> (tel) 0120 802 363 (alt) (+81) 426 56 7498 (fax) (+81) 426 60 8953	<b>Singapore</b> (tel) 1 800 275 0880 (fax) (+65) 6755 1235 (fax) (+65) 6755 1214	<b>South Korea</b> (tel) 080 778 0011 (fax) 080 778 0013
<b>Taiwan</b> (tel) 0800 047 669 (fax) 0800 047 667 (fax) 886 3492 0779	<b>Thailand</b> (tel) 1 800 2758 5822 (alt) (+66) 2267 5913 (fax) 1 800 656 336	<b>Malaysia</b> (tel) 1800 880 399 (fax) 1800 801 054	
<b>Europe</b>			
<b>Austria</b> (tel) 0820 87 44 11* (fax) 0820 87 44 22	<b>Belgium</b> (tel) (+32) (0)2 404 9340 (alt) (+32) (0)2 404 9000 (fax) (+32) (0)2 404 9395	<b>Denmark</b> (tel) (+45) 7013 1515 (alt) (+45) 7013 7313 (fax) (+45) 7013 1555	<b>Finland</b> (tel) (+358) 10 855 2100 (fax) (+358) (0) 10 855 2923
<b>France</b> (tel) 0825 010 700* (alt) (+33) (0)1 6453 5623 (fax) 0825 010 701*	<b>Germany</b> (tel) 01805 24 6333* (alt) 01805 24 6330* (fax) 01805 24 6336*	<b>Ireland</b> (tel) (+353) (0)1 890 924 204 (alt) (+353) (0)1 890 924 206 (fax) (+353) (0)1 890 924 024	<b>Israel</b> (tel) (+972) 3 9288 500 (fax) (+972) 3 9288 501
<b>Italy</b> (tel) (+39) (0)2 9260 8484 (fax) (+39) (0)2 9544 1175	<b>Luxemburg</b> (tel) (+32) (0)2 404 9340 (alt) (+32) (0)2 404 9000 (fax) (+32) (0)2 404 9395	<b>Netherlands</b> (tel) (+31) (0)20 547 2111 (alt) (+31) (0)20 547 2000 (fax) (+31) (0)20 547 2190	<b>Russia</b> (tel) (+7) 095 797 3963 (alt) (+7) 095 797 3900 (fax) (+7) 095 797 3901
<b>Spain</b> (tel) (+34) 91 631 3300 (alt) (+34) 91 631 3000 (fax) (+34) 91 631 3301	<b>Sweden</b> (tel) 0200 88 22 55* (alt) (+46) (0)8 5064 8686 (fax) 020 120 2266*	<b>Switzerland (French)</b> (tel) 0800 80 5353 opt. 2* (alt) (+33) (0)1 6453 5623 (fax) (+41) (0)22 567 5313	<b>Switzerland (German)</b> (tel) 0800 80 5353 opt. 1* (alt) (+49) (0)7031 464 6333 (fax) (+41) (0)1 272 7373
<b>Switzerland (Italian)</b> (tel) 0800 80 5353 opt. 3* (alt) (+39) (0)2 9260 8484 (fax) (+41) (0)22 567 5314	<b>United Kingdom</b> (tel) (+44) (0)7004 666666 (alt) (+44) (0)7004 123123 (fax) (+44) (0)7004 444555		
(tel) = primary telephone number; (alt) = alternate telephone number; (fax) = FAX number; * = in country number			
11/16/04			



# STEP ATTENUATORS

FOR OEM & SYSTEM USE  
dc to 26.5 GHz

models  
HP 33320A/B/G/H  
HP 33321A/B/D/G/H/K  
HP 33322A/B/G/H  
HP 33323K

TECHNICAL DATA 1 MAY 1990



## Features:

- Broadband Frequency Coverage (dc-4 GHz, dc-18 GHz, and dc-26.5 GHz)
- Optional Calibration Data
- 0 to 11 dB, 70 dB, 90 dB, 110 dB
- 1 dB Steps, 10 dB Steps
- High Accuracy ( $\pm 2\%$  of dB reading to 18 GHz Typical)
- High Repeatability (0.01 dB to 18.0 GHz Typical)
- Manual and Programmable Models
- Environmentally Rugged; Small Size; Low Cost; Long Life

# Product Information

## General Description

This family of HP step attenuators represents the state-of-the-art in attenuator design. These attenuators offer an unprecedented combination of broadband accuracy, high repeatability, small size, rapid switching, and low cost. They are particularly well suited for controlling the signal levels of microwave sweepers, spectrum analyzers, network analyzers, receivers, and automatic and special test equipment. These attenuators have proven extremely reliable inside Hewlett-Packard's microwave instrumentation as well as a wide variety of other applications. For bench use applications, models HP 8494, HP 8495 and HP 8496 are available in manual and programmable versions. Bench models include a base and the manual model has an indicator dial.

Each attenuator is composed of three or four attenuation sections connected in cascade. Each section (Figure 1) consists of a precision thin-film attenuation card, a lossless thru line, and a ganged pair of contacts that switch the attenuation card in or out. This combination results in high accuracy and exceptional repeatability.

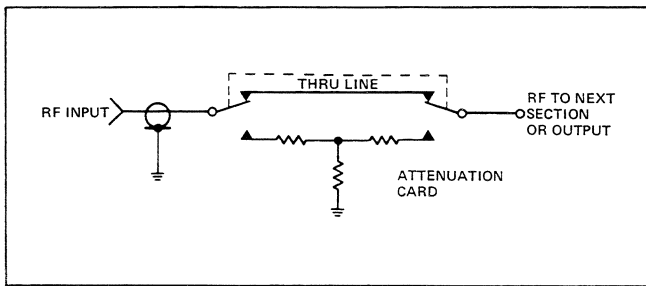

Figure 1. Schematic of Single Attenuator Section.

## High Repeatability

Excellent repeatability (typically 0.01 dB to 18 GHz and 0.05 dB to 26.5 GHz for up to five million cycles) has been achieved by employing edge-line design for the transmission line.<sup>1</sup> This construction requires that only the center conductor be switched, thus eliminating the high friction contacts characteristic of turret type attenuators. The resulting benefits are long life and highly repeatable performance.

## Reliable Performance

Each unit is tested over its operating frequency range by a computer-controlled HP Automatic Network Analyzer to insure consistent accurate measurements, traceable to the National Institute of Standards and Technology. This measurement system brings standards lab accuracy to production testing and assures that each attenuator meets specifications over the entire frequency range. Calibration data can be provided on request.

## Broadband Accuracy and Low SWR

High accuracy (typical  $\pm 2\%$  of the dB reading to 18 GHz and  $\pm 4\%$  of the dB reading to 26.5 GHz) and low SWR are achieved through the use of miniature thin-film attenuation cards composed of high stability tantalum resistive film on a sapphire substrate. This thin-film technique permits the construction of circuits which are truly distributed and without stray reactances, even at very high microwave frequencies. These precision cards and the cascaded section design provide high step-to-step accuracy, typically better than  $\pm 1$  dB to 18 GHz and  $\pm 2$  dB to 26.5 GHz for a 10-dB step and  $\pm 0.2$  dB for a 1-dB step.

Figures 2 and 3 show the typical performance of the step attenuators as tested on a computer-controlled HP Automatic Network Analyzer. This typical data represents a mean sampling of current production and is given to provide useful applications information. Special selections can be made on request.

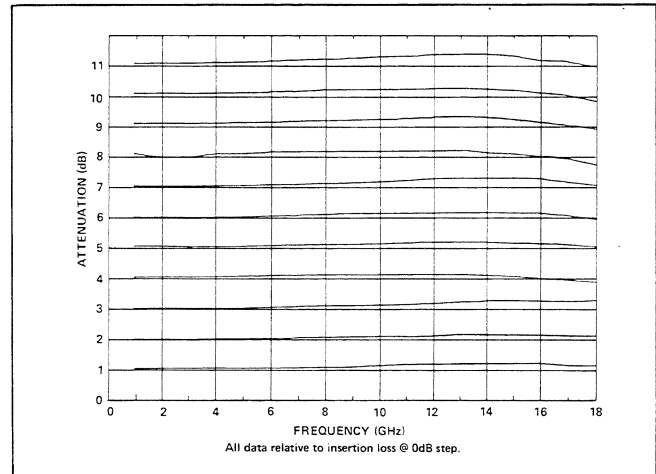

Figure 2. HP 33320B/H Typical Accuracy as Measured on an HP Automatic Network Analyzer.

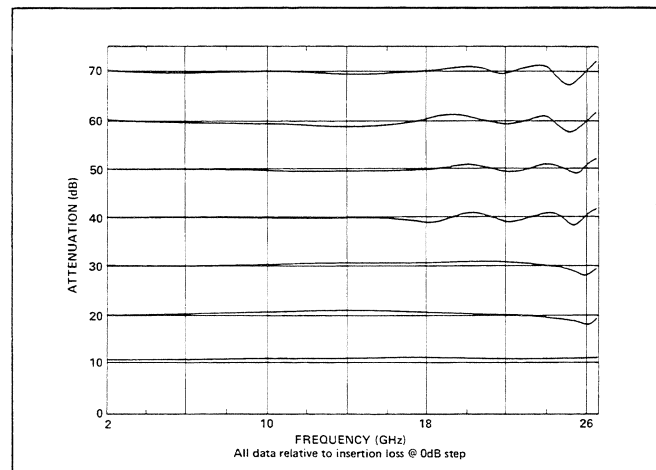

Figure 3. HP 33321 Typical Accuracy as Measured on an HP Automatic Network Analyzer (Band H models operate to 18 GHz, D and K models operate to 26.5 GHz).

<sup>1</sup>HP Journal Article, May 1974, p. 21.

## Product Information

### 3.5 mm Connector

The HP 33321D/K and HP 33323K step attenuators use the 3.5 mm connector<sup>2</sup> which is compatible with the industry standard SMA but is more rugged and offers improved repeatability over hundreds of connections. Use of this connection extends the frequency range to 26.5 GHz.

### Environmentally Rugged

HP 33320 Series Attenuators have undergone a very extensive environmental qualification program and have been tested at the extremes of temperature, shock, vibration, and humidity and have proven to be extremely reliable. A summary of the environmental data is given on the specifications page.

<sup>2</sup>"A High Performance 3.5 mm Connector to 34 GHz," Microwave Journal, July 1976. Also, IEEE Transaction on MTT, December 1976, Volume MTT-24 Number 12, page 995.

### Small Size

The small size of these attenuators is an important feature for applications where space is critical. When panel mounted, the manual versions take less than 1.5 square inches of panel area. Since the programmable models are only slightly larger than the manual versions and have the same RF performance, the designer gets more flexibility in providing manual and programmable models of instruments without major redesign.

### Low Cost

Utilizing state-of-the-art manufacturing processes, including numerically controlled machining, thin-film deposition, and computer controlled testing, this family of attenuators offers a significant technical contribution at a low cost to the user. In addition, OEM quantity discounts are offered.

## Programmable Model Information

### Positive Latching Solenoids

In the programmable models, solenoids are used to switch the attenuation card of each section into and out of the circuit. Once switched, the solenoids are held in place by strong permanent magnets able to withstand shocks over 10 G's. Thus, power can be removed without affecting the status of the attenuator sections.

### Rapid Switching

Use of miniature solenoids has resulted in more than a two-to-one improvement in switching speed over previous models. The 20 millisecond maximum switching time includes contact settling and is a significant advantage for automatic testing, and other applications where speed is of prime importance.

### Low Heat Dissipation

A unique design feature of these attenuators is that the solenoids automatically disconnect after switching. Current is drawn for approximately eight milliseconds during a switching operation, after which internal relay contacts open the solenoid circuit, and current is not drawn again until another switching operation is performed. This automatic turnoff feature greatly simplifies the driver circuit design (Figure 5) and minimizes the amount of heat dissipated by the solenoids, often a critical concern. For example, in an application with 60 switchings a minute, the average power dissipated is less than 0.03 watts.

## HP-IB Attenuator/Switch Driver



Employing programmable HP step attenuators and switches in an automatic test system becomes an easy task when the HP 11713A Attenuator/Switch Driver is specified into the system.

The HP 11713A has all of the necessary features to provide HP-IB control of up to two programmable attenuators of the HP 33320 Series, and concurrently up to two electromechanical switches (e.g., HP 8671B or HP 33311 series).

The HP 11713A includes an integral power supply (with short circuit protection) that can simultaneously provide 125 milliamps at 24 volts to all contacts for control of the attenuators and switches, so no external power supply is needed. Each HP 11713A is provided with two (2) plug-in drive cables for the programmable attenuators to simplify connection to the driver.

The HP 11713A also features convenient front panel keys so the user can manually activate the individual attenuation sections and switches when in the "local" mode. Switching time for the drivers is less than 10 milliseconds.

# Optional Calibration Data for HP 33320 Series Step Attenuators

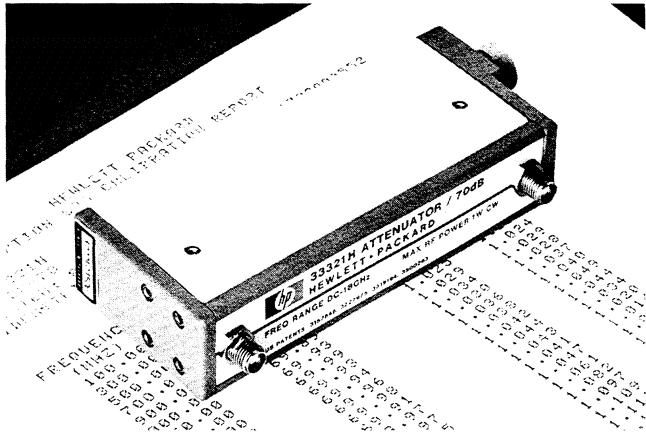

Use of calibration data (i.e. accurate, recorded data of a device's characteristics) has always been an effective means of reducing measurement uncertainty at RF and microwave frequencies. Now, however, use of calibration data is experiencing rapid growth in test systems because inexpensive calibration data is available. Another key reason for this trend is that automated test systems can easily store and manipulate extensive amounts of the calibration data.

There are three primary uses for optional test data:

## 1. Accuracy Enhancement

Step attenuators have long been used as reference standards in the measurement of gain, attenuation, and receiver sensitivity. Since the accuracy specifications include margins for frequency response and unit-to-unit variations, calibration data can improve overall measurement uncertainty. In many cases, this improves the reference attenuator's accuracy by 60 percent or more.

## 2. Test System Verification

Calibration data has an important use in ensuring that a test system is operating properly. As a final step in the verification procedures of the automatic systems by Hewlett-Packard to test microwave devices, a previously calibrated attenuator is tested and compared to the stored data. If the differences are within the system measurement uncertainty, proper operation of the test system is ensured.

## 3. Implementing Calibration Data in a Computer Program

To integrate the calibration data into an automated measurement program, first set up variables in the computer program that will be loaded with the data. Then measurements can be made at the calibration frequencies after which the calibration data is recalled and used to adjust the measured data or calculate measurement uncertainties.

Data is available on HP 33320 Series Step Attenuators as Option 890 and is generated from measurements made by an Automatic Network Analyzer. Option 890 provides a tabulated list of attenuation and SWRs for each step at 14 to 72 frequencies (see Table 1). Measurements through 50 dB are

directly traceable to NIST standards and feature very low measurement uncertainties (see Tables 2 and 3). Step attenuator data provided from 60 dB to 110 dB is generated by combining the measured data of the individual attenuation sections (e.g. adding the data for the 10, 20, and 40 dB sections to get the 70 dB step data). Option 890 data is available when the attenuators are first purchased and recalibrations are available.

**Table 1. HP 33320 Series Calibration Frequencies**

Model	Calibration Frequencies
33320A/G 33321A/G 33322A/G	200 to 4000 MHz every 200 MHz (20 frequencies)
35320B/H 33321B/H 33322B/H	200 to 18000 MHz every 200 MHz (90 frequencies)
33321D/K 33323K	1500 to 26500 MHz every 250 MHz (101 frequencies)

**Table 2. HP 33320 Series SWR Data Uncertainty**

Connector Type	Frequency Range (GHz)	SWR Data Uncertainty	
		Measured SWR 1.0 to 1.35	Measured SWR 1.35 to 1.86
Female SMA	dc to 8.0	±0.054	±0.088
	8.0 to 12.4	±0.077	±0.132
	12.4 to 18.0	±0.122	±0.206
Female APC-3.5	18 to 26.5	±0.045	±0.067

**Table 3. HP 33320 Series Attenuation Data Uncertainties**

Attenuation (dB)	Attenuation Data Uncertainty (dB)				
	0.1 to 2.0 GHz	2 to 6 GHz	6 to 12.4 GHz	12.4 to 18.0 GHz	18.0 to 26.5 GHz
0/0-4	±0.07	±0.06	±0.06	±0.11	±0.3
5-8	±0.07	±0.07	±0.07	±0.11	—
10/9-11	±0.08	±0.07	±0.07	±0.12	±0.2
20	±0.09	±0.08	±0.08	±0.13	±0.2
30	±0.12	±0.11	±0.11	±0.15	±0.24
40	±0.15	±0.14	±0.14	±0.21	±0.28
50	±0.23	±0.23	±0.23	±0.34	±0.54
60	±0.50*	±0.48*	±0.90*	±0.90*	±1.00*
70	±0.50*	±0.50*	±0.90*	±0.90*	±1.75*
80	±0.50*	±0.50*	±0.90*	±0.90*	±1.80*
90	±0.50*	±0.50*	±0.90*	±0.90*	±1.95*
100	±0.90*	±0.90*	±1.80*	±1.80*	—
110	±0.90*	±0.90*	±1.80*	±1.80*	—

\*For step attenuator data from 60 to 110 dB the uncertainties noted represent 99.7% probability values.



# Installation Information

## Attenuation Section Switching

Figure 4 shows one attenuator section schematic. Each attenuation section utilizes one solenoid with dual coil windings, one coil to switch in the attenuation card (e.g. 10 dB) and one coil to switch in the thru line (0 dB).

With a positive voltage applied to the common pin, the state (attenuation card or 0 dB) of a particular section is determined by connecting its attenuation card pin or thru line pin to a negative voltage or ground. Table 4 defines the pin assignments and the pin configurations are shown on page 8.

As a section is switched, the internal contacts of the activated coil open, thus shutting off current flow. At the same time, the internal contacts for the other coil close so that it can be activated when desired. Figure 5 shows a section that has been switched to the attenuation card position (note the closed thru line coil contact). The switching is “break-before-make” type, thus a momentary interruption of the RF signal occurs at switching.

Although all sections can be switched simultaneously, the attenuator driver must not allow both pins of the same section (e.g. Section 1, pins 5 and 6) to be activated concurrently, or else that section would cycle rapidly. All terminals are “floating”, so bipolar or unipolar power supplies can be used.

## Typical Driver Circuit

Figure 5 shows an economical TTL compatible driver circuit for a single attenuation section utilizing an IC relay driver and an inverter. A TTL “HI” input to the driver switches in the attenuation card, while a “LO” will activate the thru line for that section. This provides a complementary driver for the section which assures that only one solenoid of the pair is activated at a time. Diode protection is required to protect the IC from the solenoid voltage flyback.

Switch position can be indicated remotely by utilizing the open and closed states of the internal coil contacts. The shaded areas of Figure 5 display two indicator circuits, one providing a

Table 4. Solenoid pin and color code assignment guide.

Section	Section 1		Section 2		Section 3		Section 4	
Solenoid Coil <sup>1</sup>	Thru Line	Atten. Card	Thru Line	Atten. Card	Thru Line	Atten. Card	Thru Line	Atten. Card
Cable Wire Color Code <sup>1</sup>	PUR	YEL	BLK	GRN	ORN	BLU	BRN	WHT
Connector Plug Pin Number <sup>2</sup>	5	6	7	8	9	10	11	12
Opt.008/016 Ribbon Wire Color Code	BLK	WHT	BLU	ORN	VIO	RED	GRN	YEL
Flat Pack Plug Pin Number <sup>3</sup>	13	2	11	5	3	9	4	10
33320G/H (11 dB)	0 dB	1 dB	0 dB	2 dB	0 dB	4 dB	0 dB	4 dB
33321G/H (70 dB)	0 dB	10 dB	0 dB	20 dB	0 dB	40 dB	*	*
33321K* (70 dB)	0 dB	10 dB	0 dB	20 dB	0 dB	20 dB	0 dB	20 dB
33323K* (90 dB)	0 dB	10 dB	0 dB	20 dB	0 dB	30 dB	0 dB	30 dB
33322G/H (110 dB)	0 dB	10 dB	0 dB	20 dB	0 dB	40 dB	0 dB	40 dB

\*Not Used  
<sup>1</sup>Five-foot cable and mating plug assembly provided.  
<sup>2</sup>Pin 1 (red wire) is common for all coils. Pins 2, 3 and 4 are not used on all models. See connector pin diagram in Figure 7, page 8.  
<sup>3</sup>Pin 6 (brown wire) is common for all coils. Pins 1, 7, 8, 12, and 14 are not used.  
<sup>4</sup>See page 6 for recommended switching sequence for the 33321/23K. Also see Figure 8, page 8.

TTL output and one that activates an LED. These circuits will output a TTL ‘HI’ (LED lamp ‘ON’) if the attenuation card is in the RF circuit, and will output a TTL ‘LO’ (LED) lamp ‘OFF’) if the thru line is in the RF circuit. Since current is drawn through the coil for these circuits, inadvertent switching is prevented by limiting the current to 5 mA.

Hewlett-Packard assumes no responsibility for the use of any circuits described herein and makes no representation or warranties, express or implied, that such circuits are free from patent infringement.

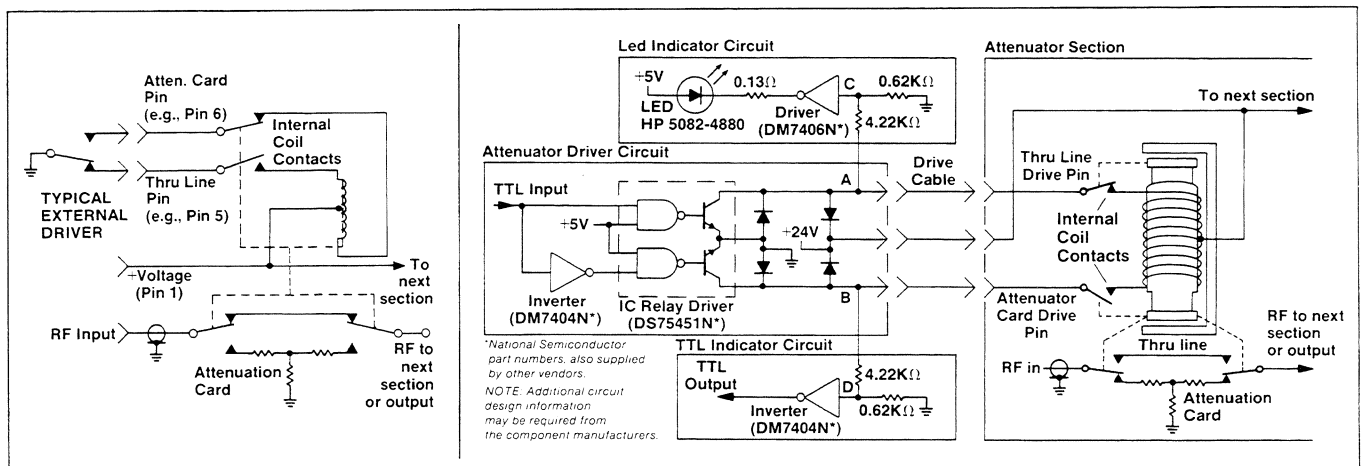

Figure 4. Section electrical diagram.

Figure 5. Driver and indicator circuits for one section of an HP 33320, 1, 2, 3, G/H/K

# Specifications

Specifications describe the instrument's warranted performance. Supplemental characteristics are intended to provide information useful in applying the instrument by giving typical, but non-warranted, performance parameters. These are denoted as "typical", "nominal", or "approximate".

## Electrical

**Attenuation Accuracy** ( $\pm$  dB Referenced from 0-dB Setting):

HP Models 33320A/B/G/H (11 dB max*)											
Frequency Range	Attenuator Setting (dB)										
	1	2	3	4	5	6	7	8	9	10	11
dc-4 GHz (A,G only)	0.2	0.2	0.3	0.3	0.3	0.3	0.4	0.4	0.4	0.4	0.5
dc-12.4 GHz (B,H only)	0.3	0.3	0.4	0.4	0.5	0.5	0.6	0.6	0.6	0.6	0.7
12.4-18.0 GHz (B,H only)	0.7	0.7	0.7	0.7	0.7	0.8	0.8	0.8	0.8	0.9	0.9

\*Typical step-to-step accuracy is  $\pm$  0.2 dB to 18 GHz

HP Model Numbers	33321A/B/G/H (70 dB max*)										
	33322A/B/G/H (110 dB max*)										
Frequency Range	Attenuator Setting (dB)										
	10	20	30	40	50	60	70	80	90	100	110
dc-4 /GHz (A,G only)	0.2	0.4	0.5	0.7	0.8	1.0	1.2	1.3	1.5	1.6	1.8
dc-12.4 GHz (B,H only)	0.5	0.7	0.9	1.2	1.5	1.8	2.1	2.4	2.7	3.0	3.3
12.4-18.0 GHz (B,H only)	0.6	0.8	1.2	1.6	2.0	2.4	2.8	3.2	3.6	4.0	4.4

\*Typical step-to-step accuracy is  $\pm$  1 dB to 18 GHz.

HP Model Numbers	33321D/K (70dB max*)								
	33323K (90 dB max*)								
Frequency Range	Attenuator Setting (dB)								
	10	20	30	40	50	60	70	80	90
dc-6.0 GHz	0.3	0.5	0.6	0.7	0.8	1.0	1.1	1.1	1.2
6.0-12.4 GHz	0.4	0.5	0.7	0.9	1.0	1.3	1.5	1.6	1.7
12.4-18.0 GHz	0.5	0.6	0.8	1.1	1.2	1.4	1.7	1.8	2.1
18.0-26.5 GHz	0.7	0.8	1.0	1.5	1.6	1.9	2.3	2.5	2.8

\*Typical step-to-step accuracy is  $\pm$  0.6 dB to 18 GHz  
 $\pm$  0.9 to 26.5 GHz.

To insure warranted specifications for the HP 33321K, and HP 33323K, the following combination of sections is recommended.

Attenuation (dB)	10	20	30	40	50	60	70	80	90
HP 33321K	1	4	1.4	2.4	1.2,4	2.3,4	1.2 3.4	—	—
HP 33323K	1	2	4	1.4	2.4	3.4	1.3,4	2.3,4	1, 2 3, 4

**SWR** (Characteristic Impedance: 50 ohms)

HP Model	Frequency (GHz)				
	dc-4	4-8	8-12.4	12.4-18	18-26.5
33320A/G 33322A/G	1.5 1.5	—	—	—	—
33320B/H 33322B/H	1.5 1.5	1.5 1.5	1.6 1.6	1.9 1.9	—
33321A/G	1.35	—	—	—	—
33321B/H	1.35	1.35	1.5	1.7	—
		dc-6	dc-12.4		
33321D/K 33323K	1.25 1.25		1.45 1.45	1.6 1.6	1.8 1.8

**Attenuation Temperature Coefficient:** Less than 0.0001 dB/dB/°C.

**Power Sensitivity:** 0.001 dB/watt.

**RF Input Power (max.):** 1 watt average, 100 watts peak (10  $\mu$ s pulse width).

**Life, Minimum:** 5 million cycles per section.<sup>1</sup>

**Repeatability:** 0.01 dB, typical to 18 GHz, 0.05 dB, typical to 26.5 GHz.

**Insertion Loss** (0 dB position, f is frequency in GHz):

HP 33320A/B/G/H:  $(0.6 + 0.09 \times f)$  dB

HP 33321A/B/G/H:  $(0.4 + 0.07 \times f)$  dB

HP 33321D/K/:  $(0.4 + 0.09 \times f)$  dB

HP 33322A/B/G/H:  $(0.6 + 0.09 \times f)$  dB

HP 33323K:  $(0.4 + 0.09 \times f)$  dB

<sup>1</sup>A cycle is defined as switching from the thru-line position to the attenuation card and back to the thru-line position or vice versa.

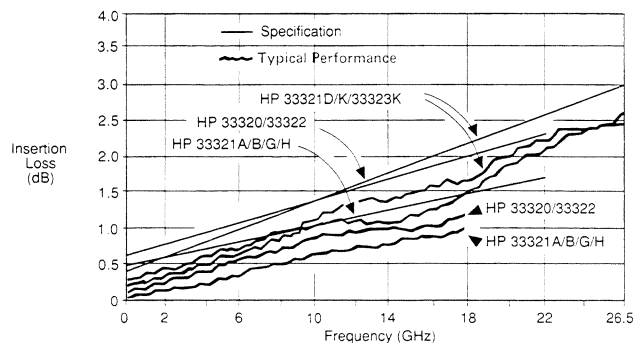

# Specifications

## Environmental Capabilities\*

**Temperature, Operating:** -20° to +75°C.

**Temperature, Non-Operating:** -55°C to +85°C.

**Altitude, Operating:** 15,000 ft.

**Altitude, Non-operating:** 50,000 ft.

**Humidity:** Cycling 5 days, 40°C at 95% RH with condensation.

**Shock, Operating:** 10 g's, 6 ms, on six sides, three blows.

**Shock, Non-operating:** 500 g's, 1.8 ms, in 6 directions.

**Vibration, Operating:** 5 g's, 34-2000 Hz (for all models except the HP 33321D/K); 0.015 inches DA, 5-55 Hz (for the 33321D/K only).

**EMC:** radiated interference is within the requirements of MIL-STD-461 method RE02, VDE 0871 and CISPR Publication II.

\*Additional environmental data provided on request.

## Mechanical

**Mounting Position:** Any.

**Net Weight:**

**HP 33321** } A/B: 198 grams (7 oz); G/H: 227 grams  
**HP 33323** } (8 oz); D: 255 grams (9 oz); K: 284 grams  
 (10 oz).

**HP 33320** } A/B: 255 grams (9 oz); G/H 284 grams  
**HP 33322** } (10 oz).

**RF Connectors:** SMA female for HP 33320/1/2  
 A/B/G/H. APC-3.5 female (SMA compatible) for  
 HP 33321D/K & HP 33323K.

## Programmable Models (G, H, K)

**Switching Speed:** Max. 20 msec including settling time.

Solenoids	Coil Voltage	Switching Current*	Nominal Coil Impedance
Standard (G, H, and K models)	24V (20 - 30V)	125 mA (@ 24V)	190Ω (65 mh)
Option 011 (G & H models plus HP33323K)	5V (4 - 7V)	300 mA (@ 5V)	17Ω (5.5 mh)
*Current per section; approximately 8 msec duration before internal contacts open the coil circuit.			

## Accessory provided (except Option 008 & 016)

Solenoid drive plug on 5-foot cable included with programmable models. (Replacement plug and cable assembly available as HP Part Number 8120-2178.)

## Step Attenuator Selection Guide

To order, basic model number and suffix letter must be specified. The basic model number defines the step size and maximum attenuation value. HP 33320 (1-dB step, 11-dB max.) HP 33321 (10-dB step, 70-dB max.), HP 33322 (10-dB step, 110-dB max.), HP 33323 (10-dB step, 90 dB max.). The suffix letter denotes frequency range and switching mode (manual or programmable); A, B, and D denote dc — 4 GHz, dc — 18 GHz, and dc — 26.5 GHz respectively for the manual models; G, H, and K denote dc — 4 GHz, dc — 18 GHz, and dc — 26.5 GHz respectively for the programmable models. Standard coils are 24 volt, Option 011 specifies 5 volt.

Attenuation Step Size	Attenuation Range	Frequency Range	Switching Mode (Manual or Programmable)	HP Basic Model Number
1 dB	0-11 dB	dc-4 GHz	MAN.	33320A
			PROG.	33320G
		dc-18 GHz	MAN.	33320B
			PROG.	33320H
10 dB	0-70 dB	dc-4 GHz	MAN.	33321A
			PROG.	33321G
		dc-18 GHz	MAN.	33321B
			PROG.	33321H
		dc-26.5 GHz	MAN.	33321D
			PROG.	33321K
	0-90 dB	dc-26.5 GHz	PROG.	33323K
	0-110 dB	dc-4 GHz	MAN.	33322A
			PROG.	33322G
		dc-18 GHz	MAN.	33322B
PROG.			33322H	

## Ordering Information

Specify basic model number and suffix, per the table above.

- Option 008:** 8 inch (20.3 cm) ribbon cable with 14 pin flat pack male connector. (See back page.)
- Option 016:** 16 inch (40.6 cm) ribbon cable with 14 pin flat pack male connector (see back page.)
- Option 011:** 5 volt solenoid operation.
- Option 890:** Calibration data:  
 4 GHz models: 20 frequencies  
 18 GHz models: 90 frequencies  
 26.5 GHz models: 101 frequencies

# Dimensions

## Manual Models

For all manual models a counterclockwise rotation of the shaft increases attenuation. The angular increments are 45° for each step on the 33321A/B/D models and 30° for each step on the 33320A/B and 33322A/B models. The typical torque required for switching is only 0.75 inch-pounds. To insure proper switching, the attenuator shaft should be allowed to seek its own detent.

All models have a mechanical stop that prevents the attenuator knob from being rotated from maximum attenuation to 0 dB in one step. The maximum allowable torque to avoid damaging the stop is 5 inch-pounds.

